

MATERIKA

PORCELAIN

GEOSMALL



geotiles
cerámica

ROUNDED

-  Porcelain tile
Porcelánico
-  Gloss
Brillo
-  Hygienic and
Anti-Allergenic
Higiénico y antialérgico
-  Fireproof
Ignífugo
-  Durable and resistant
Duradero y resistente
-  Easy maintenance
Fácil mantenimiento
-  Responsible
Responsable

MATERIKA

GEOSMALL - PORCELAIN



RECTO



MATERIKA

GEOSMALL - PORCELAIN

GLOSSY



SIZES / FORMATOS



5x25 / 2"x10"



MATERIKA OCEAN (ROUNDED) 5x25 / 2"x10"

MATERIKA

GEOSMALL - PORCELAIN

GLOSSY



SIZES / FORMATOS

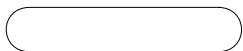

5x25 / 2"x10"



25

5



WHITE



GREY



AMBER



OCEAN



GREEN



BLUE



BLACK

Size Medida	Pcs/Box Pz/Caja	Sqm/Box m ² /Caja	Box/Pallet Cj/Palet	Sqm/Pallet m ² /Palet	Kg/Box Kg/Caja	Kg/Pallet Kg/Palet
5x25 ROUNDED	60	0,67	75	50,25	13,00	995,00

MATERIKA

GEOSMALL - PORCELAIN

GLOSSY



SIZES / FORMATOS



5x25 / 2"x10"



MATERIKA WHITE (RECTO) 5x25 / 2"x10"

MATERIKA

GEOSMALL - PORCELAIN

GLOSSY



SIZES / FORMATOS



5x25 / 2"x10"



WHITE



GREY



AMBER



OCEAN



GREEN



BLUE

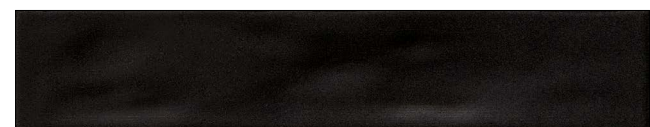









BLACK







Size Medida	Pcs/Box Pz/Caja	Sqm/Box m ² /Caja	Box/Pallet Cj/Palet	Sqm/Pallet m ² /Palet	Kg/Box Kg/Caja	Kg/Pallet Kg/Palet
5x25 RECTO	60	0,75	75	56,25	13,50	1,032.50

TECHNICAL FEATURES / CARACTERÍSTICAS TÉCNICAS

Porcelain Tiles / Porcelánico

									
STANDARD NORMES NORMAS DE ENSAYO	ISO 10545-2	ISO 10545-3	ISO 10545-4	ISO 10545-6	ISO 10545-9	ISO 10545-12	ISO 10545-13	ISO 10545-14	DIN 51130 DIN 51097 UNE-ENV 12633 ASTM C 1028
VALUE REQUIRED BY EN 14411 STANDARD VALORES PRESCRITOS NORMA EN 14411		< 0,5%	> 35 N/mm ² > 1300 N	Máx.175 mm ³	Test method available Método de ensayo disponible	Test method available Método de ensayo disponible	Test method available Método de ensayo disponible	Test method available Método de ensayo disponible	R Rating Clase
AVERAGE VALUE VALOR MEDIO	Conforms to Standard Cumple la norma	0,1%	35-45 N/mm ² 1800-2500 N	110-130 mm ³	Resists Resiste	Resists Resiste	Conforms to Standard Cumple la norma	Conforms to Standard Cumple la norma	According to models Según modelos

Group Bla (gl) Water Absorption <0.5% / Grupo Bla (gl) Absorción de Agua <0.5%

 Dimensional Features Características dimensionales	 Water absorption Absorción de agua	 Modulus of rupture Resistencia a la flexión	 Resistance to deep abrasion (mm ³) Resistencia a la abrasión profunda (mm ³)
 Thermal shock resistance Resistencia al choque térmico	 Frost resistance Resistencia a la helada	 Chemical resistance Resistencia química Ácidos y bases	Cleaning products and pool reactive agents Productos de limpieza y reactivos de piscinas
 Resistance to stains Resistencia a las manchas	 Slip Resistance Resistencia al deslizamiento		

GEOTILES reserves the right to modify the packing of any product reference.
GEOTILES se reserva el derecho a modificar el packing (en relación al espesor de la pieza).

Geotiles, S.L.U. operates a policy of continuous development and reserves the right to make changes to its products, colours, engineering specifications, packaging codes without prior notice. Geotiles has taken every effort to ensure that the information contained in the catalogue is correct at the time of publication. Due to the limitations of the printing process, the colours reproduced may vary slightly from the original product.

Geotiles, S.L.U. aplica una política de continuo desarrollo de sus productos y se reserva el derecho a realizar cambios en los productos, colores, especificaciones técnicas y códigos sin previo aviso. Geotiles ha realizado un esfuerzo considerable para que toda la información sea adecuada en el momento de la publicación del catálogo. A causa de las limitaciones del proceso de impresión los colores reproducidos pueden sufrir ligeras variaciones con respecto al producto original.

LAYING OPTIONS / OPCIONES DE COLOCACIÓN

ROUNDED

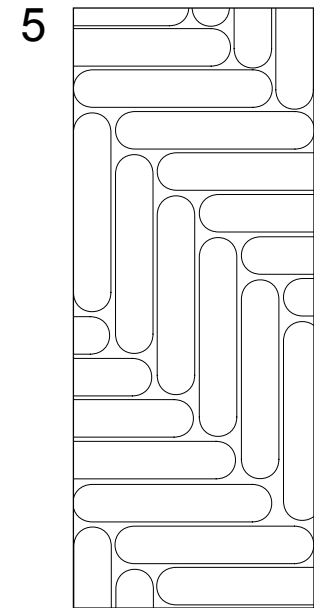
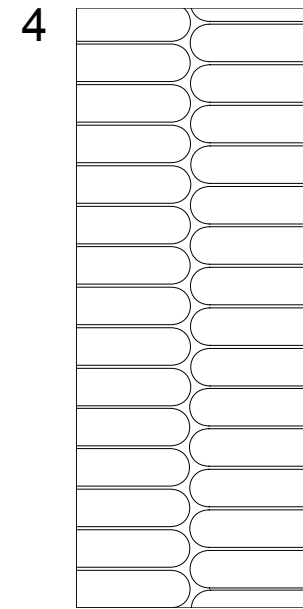
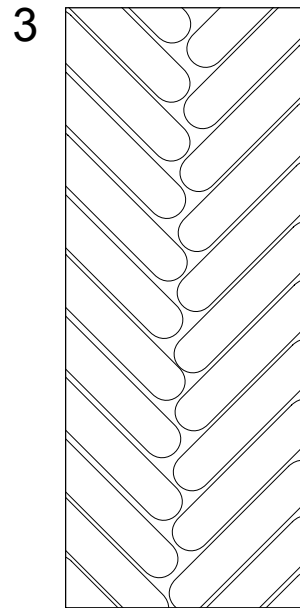
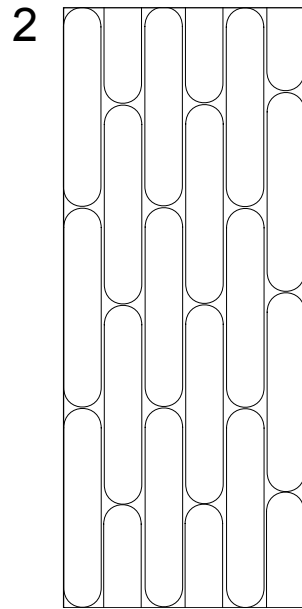
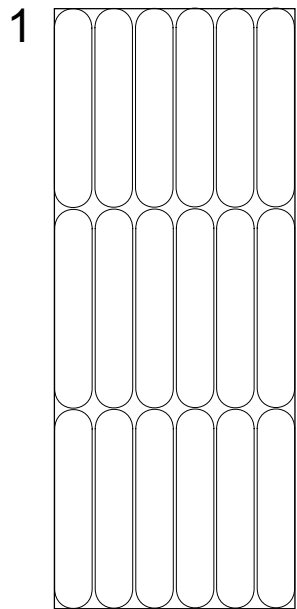

RECTO

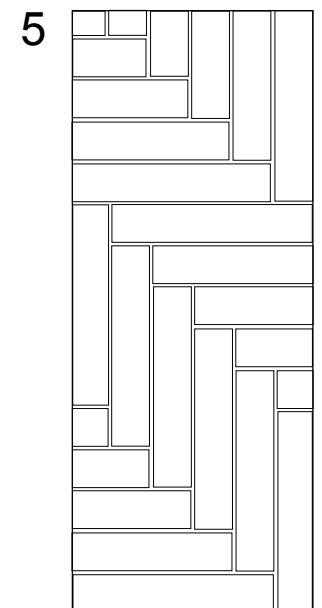
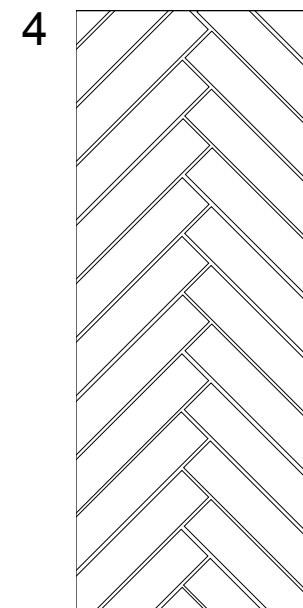
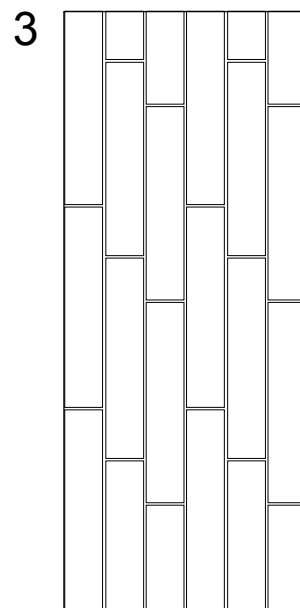
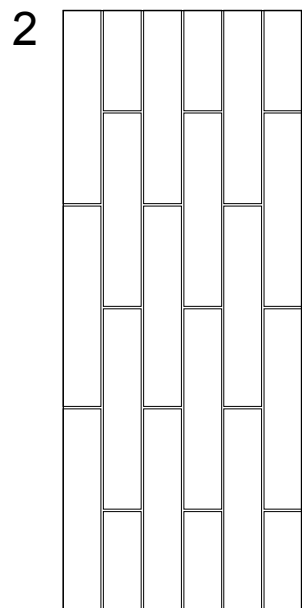
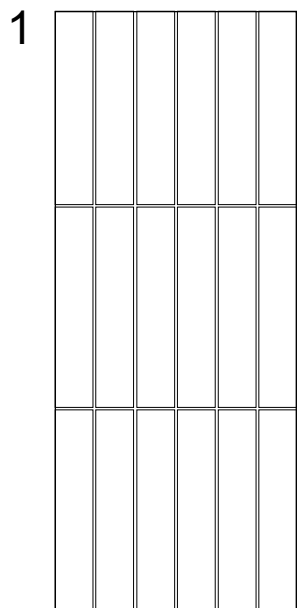



GEOTILES S.L.U. complies with all the obligations derived from the CE marking for its products defined by the European community according to the EN ISO 14411 standard.

GEOTILES S.L.U. cumple todas las obligaciones derivadas del marcado CE para sus productos definidos por la comunidad europea acorde a la norma EN ISO 14411.



The UKCA (United Kingdom Conformity Assessed Mark) is the new UK product marking that will be required for certain products that are marketed in Great Britain (England, Wales and Scotland).

El marcado UKCA (conformidad Evaluada del Reino Unido, por sus siglas en inglés) en la nueva marca del producto del Reino Unido que se requerirá para ciertos productos que se comercializan en Gran Bretaña (Inglaterra, Gales y Escocia).



The CCC certificate (China Compulsory Certificate) is applied to products for export or production in that territory. Concerns both health and safety related to ceramic tiles. The certificate is obtained through the institutes expressly accredited by the Chinese authorities.

El certificado CCC (China Compulsory Certificate), se aplica a los productos para exportar o producir en China. Conciernen tanto a la seguridad como a la salud relacionado con las baldosas cerámicas. Esta certificación la acreditan institutos autorizados por las autoridades chinas.



Geotiles, S.L.U. has implemented an Integrated Quality and Environment Management System in accordance with ISO 9001:2015 and ISO 14001:2015. Both certificates have been issued by the LRQA (Lloyd's Register Quality Assurance).

The process towards both certifications had a first stage, in which the ISO 9001 certification was obtained and that later continued with the implementation of an Integrated Management System by obtaining ISO 14001:2015 certification. ISO 9001 is an international standard norm that evaluates the Quality Management System. Its main objective is to improve customer satisfaction through continuous improvement processes, including in this the maximum effort in ensuring the quality of the products and services.

ISO 14001 is an international standard norm that demonstrates the commitment assumed with the protection of the environment through the management of environmental risks associated with the activity carried out. Environmental management must be understood as an integral part of the organization's management system, encompassing the organizational structure, responsibilities, procedures, processes and resources; in this way, attention is focused on key factors and all activities that can generate negative impacts on the environment are taken into account.

GEOTILES S.L.U. tiene implantado un Sistema de Gestión Integrado de Calidad y Medio Ambiente de acuerdo a la normativa ISO 9001:2015 e ISO 14001:2015. Ambos certificados han sido expedidos por la certificadora LRQA (Lloyd's Register Quality Assurance).

El proceso hacia ambas certificaciones tuvo una primera etapa, en la que se obtuvo la certificación ISO 9001, y que más tarde continuó con la implementación de un Sistema Integrado de Gestión al obtener la certificación ISO 14001:2015.

La ISO 9001 es una norma estándar internacional que evalúa el Sistema de Gestión de la Calidad. Su principal objetivo consiste en mejorar la satisfacción de los clientes mediante procesos de mejora continua, poniendo para ello el máximo esfuerzo en asegurar la calidad de los productos y servicios.

La ISO 14001 es una norma internacional que demuestra el compromiso asumido con la protección del medio ambiente a través de la gestión de los riesgos medioambientales asociados a la actividad desarrollada. La gestión medioambiental debe ser entendida como parte integrante del sistema de gestión de las organizaciones, comprendiendo la estructura organizativa, las responsabilidades, los procedimientos, los procesos y recursos; de esta forma, se centra la atención en factores clave y se tienen en cuenta todas las actividades que puedan generar impactos negativos sobre el medio ambiente.



(Leadership in Energy and Environmental Design) is a green certification program developed by the U.S. Green Building Council that recognizes sustainable, healthy and highly efficient building strategies and practices.

GEOTILES products are manufactured with a content of recycled material, free of VOCs, waterproof and with EPDs associated with the product that contribute to the satisfaction of the credits of the LEED® v4 certification.

For more information: <https://www.usgbc.org/leed>

Leadership in Energy and Environmental Design es un programa de certificación ecológica desarrollada por el U.S. Green Building Council que reconoce estrategias y prácticas de construcción sostenible, saludables y altamente eficientes.

Los productos de GEOTILES se fabrican con un contenido de material reciclado, libres de COVs, impermeables y con EPDs asociadas al producto que contribuyen a la satisfacción de los créditos de la certificación LEED® v4. Para mayor información: <https://www.usgbc.org/leed>



FloorScore® is the most recognized Indoor Air Quality Certification (IAQ) standard for hard surface flooring materials, adhesives, and flooring. Developed by SCS with the Resilient Floor Covering Institute (RFCI), a trade association for the flooring manufacturer and supplier industry, it qualifies for many green building schemes.

Resultado de imagen de floorscoreFloorScore® es la norma de certificación de calidad del aire interior (IAQ) más reconocida para materiales, adhesivos y contra suelos para suelos de superficie dura. Desarrollado por SCS con el Resilient Floor Covering Institute (RFCI), una asociación comercial para la industria de fabricantes y proveedores de suelos, califica para muchos esquemas de construcción ecológica.



Our products have been evaluated by carrying out a life cycle analysis, from the extraction of raw materials, through production; to the recovery of construction and demolition waste. This analysis has been carried out according to the international standards of the ISO 14040 series and has been published in the EPD environmental product declaration (ISO 14025) certified by AENOR.

Nuestros productos han sido evaluados mediante la realización de un análisis de ciclo de vida, desde la extracción de materias primas, pasando por producción; hasta la valorización de los residuos de la construcción y demolición. Este análisis se ha realizado acorde a las normas internacionales de la serie ISO 14040 y han sido publicados en la declaración ambiental de producto EPD (ISO 14025) certificadas por AENOR.



Self-declarations of the minimum % content of pre-consumer recycled material content have been made in accordance with ISO 14021-Self-declared environmental claims (Type II environmental labelling).

Mediante la norma ISO 14021-Afirmaciones ambientales auto declaradas (Etiquetado ambiental tipo II) se han conformado autodeclaraciones de % de contenido mínimo de materia reciclada en pre-consumo.



French certification for products that defines the conformity of the final product with the QB-32 and cahier 3778 standards of NF-UPEC regarding the technical characteristics according to the usability and purpose of the product.

Certificación francesa para productos que define la conformidad del producto final con las normas QB-32 y cahier 3778 de NF-UPEC respecto a las características técnicas acorde a la usabilidad y finalidad del producto.



Certification defining the conformity and technical characteristics of our product in the SASO ISO 13006/20188 for export to Saudi Arabia.

Certificación que define la conformidad y características técnicas de nuestros productos en la SASO ISO 13006/2018 en su exportación a Arabia Saudí.

geotiles
cerámica

GEOFILES, S.L.U.
Carretera Vila-real - Onda, Km.6
Apdo Correos 116
12540 Vila-real (Castellón) SPAIN
Tel.: +34 964 522 700
www.geotiles.com